



FLITZEN KERAMIK

Cast Iron Machining Solutions



Your Trusted Expert for Cast Iron Machining Solutions



FLITZEN KERAMIK

Safety instructions for using ultra hard cutting tools

1. Instructions for using ultra hard cutting tools

As required by the laws concerning Product Liability enforced on July 1, 1996, we place warning or caution labels on the packages of applicable FK products. However, each tool body itself bears no detailed safety instructions. Therefore, you are requested to read and understand fully the "Safety instructions for the use of carbide cutting tools" before putting any ultra hard tool materials into use. In addition, we request all relevant staff and operators fully understand these safety instructions prior to use.

2. Basic characteristics of ultra hard tool materials

2-1. Meaning and classifications of terms used in this leaflet

Ultra hard tool materials: The collective name for materials used as cutting tools, including carbides, ceramics, CBN and diamond (PCD) sintered materials.

Carbide: Tool materials where the main component is WC (Tungsten Carbide)

Ultra hard materials: The collective name for materials used as ultra hard tools. Also used as a convenient way of referring to carbides under a narrower definition.

Ultra hard tools: The collective name for tools using ultra hard tool materials.

2-2. Physical properties

Appearance: Varies depending on the material. Example: gray, black or gold

Odour: No odour

Hardness: Cemented carbide: HV500 up to 3,000 kg/mm²

Specific gravity: Carbide: 9 up to 19

2-3. Constituents

Carbide, nitride, carbo-nitride, or oxidized materials of W, Ti, Al, Ta, B or the like; some contain metallic components such as Co, Ni, Cr and/or Mo.

3. Precautions for handling ultra hard tool materials

- * One of the properties specific to these materials is high hardness, another is brittleness. Therefore, shock loads or impacts, or excessive clamping of these materials may result in breakage or other damage.
- * As the specific gravity (density) of these materials is very high, a large component made up of these materials or such products in large quantity should be handled with care.
- * Ultra hard materials are different in their thermal expansion ratio from metals. These products are prone to thermal shock and subsequent breakage when subjected to sudden increase or decrease in temperature.
- * As cutting oil, lubricant and general moisture may corrode ultra hard materials and affect their strength, pay extra attention to storing them in good conditions.

4. Precautions for processing ultra hard tools

- * The strength of ultra hard tools may be significantly lowered depending on the surface condition. Always use diamond grinding wheels for finish machining.
- * Dust is produced when ultra hard tools are ground. Install appropriate ventilation/disposal equipment and wear protective gear such as masks, as inhalation of such dust may be hazardous to health. If such dust contacts your skin or comes into contact with your eyes, flush well with flowing water.
- * After the grinding of ultra hard tools or brazed tools, the waste coolant contains components of heavy metals. Be sure to dispose of such waste liquid properly.
- * After re-grinding ultra hard tools, check that they are free of cracks or damage before use.
- * When ultra hard material or products made of ultra hard material is marked with lasers or an electric pen, cracking may occur to the marked area. Do not mark in areas where stress is applied during use.
- * Processing ultra hard material by electric discharge may cause residual cracks on the surface, resulting in lower strength. Thus, remove any cracks completely by grinding as required.
- * Be careful when brazing ultra hard material. If the temperature is lower or higher than the melting point of the brazing material, the insert may not be permanently fixed.

< Precautions for Safe Use of Cutting Tools

Applicable Products	Possible Risks	Safety Measures
General Cutting Tools	< Contact with a sharp cutting edge with bare hands may result in injury.	* Use protective gear s such as protective gloves when taking the tool out of packaging and installing into the machine.
	< Misuse or using under in appropriate conditions may cause the cutting tool to break and/or shatter into pieces, resulting in personal injury.	* Use protective equipment, machine guarding and/or protective glasses. * Use within the range of recommended conditions. Please refer to the instruction manual and catalogue.
	< Sudden increase in cutting resistance due to sudden impact load or excessive wear may cause the cutting tool to break and/or shatter into pieces, resulting in personal injury.	* Use protective gear such as protective gloves when taking the tool out of packaging and installing into the machine.
	< High-temperature chips may be produced and long chips may be ejected, resulting in injury and/or burns.	* Use protective equipment, machine guarding and/or protective glasses. * Before removing chips, always stop the machine. Wear protective gloves and use proper equipment for chip removal.
	< The tool and material/work being cut can become very hot. Touching them immediately after use may cause burns.	* Use protective gear such as protective gloves.
	< Sparks, heat generation due to breakage and/or chips during cutting may cause fire.	* Do not use the machine and tools in locations where there are risks of ignition or explosion. * When using water-insoluble cutting oil, fire prevention measures must be implemented.
	< Out of balance machine set ups when used at a high-speed, may cause insert breakage due to excess vibration or chatter, resulting in injury.	* Use protective equipment, machine guarding and/or protective glasses. * Perform a trial-run beforehand to make sure the setup is stable, free of chatter, vibration and abnormal noise.
	< Touching burrs and flashes on machined work may result in personal injury.	* Use adequate hand protection.
Throw-Away Type Tools (With indexable insert)	< In appropriately clamped inserts and/or components may become detached from the machine during cutting, resulting in injury.	* Before installing the insert, clean the seating surface and clamping components so that they are free of debris. * Use the wrench supplied to install the insert and check that the insert and components are securely clamped. Do not use any inserts or components other than the items specified.
	< Excessively tightening with a device such as a pipe extension may cause the insert and/or components to break or detach due to over clamping.	* Do not use tightening devices such as pipe extensions to obtain further torque. Always use the supplied wrench.
	< At a high speeds inserts and/or components may lose clamping pressure due to the loosening effect of centrifugal force. This is very dangerous. Always ensure secure clamping systems and check regularly.	* Use within the range the recommended conditions. Please refer to the instruction manual and catalogue.
Cutters and Rotational Tools	< As cutters have sharp cutting edges, contact with bare hands may result in injury.	* Use protective equipment such as protective gloves.
	< Imbalance or eccentric rotation may cause the tool to break due to vibration or chatter, resulting in potential injury.	* Use at a rotational speed within the recommended conditions. * To prevent eccentric rotation and vibration due to worn bearings, regularly check the machine rotor/rotating parts for the accuracy and balance and adjust as required.
Drills	< Extra care should be taken when through hole drilling as chips may be ejected at high speed as the drill breaks through the workpiece.	* Use protective equipments such as machine guards and/or protective glasses. Additional guarding around the chuck and drill may be advisable.
	< Drill tips of a very small diameter are usually pointed and extremely sharp. Extra care and safety precautions should be taken when handling to avoid puncture wounds.	* Always use precautions and secure safe handling methods. * Wear protective gloves and glasses.
Brazed Inserts / Tools	< Inserts may break or become, detached due to incorrect brazing.	* Use protective equipment such as machine guards and/or protective glasses. Additional guarding around the chuck and drill may be advisable.
Others	< It is not advisable to use repeatedly brazed inserts as the braze may progressively weaken.	* Do not use repeatedly brazed inserts as the strength of such inserts is lowered.
	< Use only for the original and intended purpose. Using outside recommended parameters is very dangerous, causing damages to machines and/or tools.	* Always use and operate as specified, observing the required safety rules and conditions.



Ceramics



FK Ceramic Tools ensure highly efficient machining with their superior high temperature hardness, heat resistance and chemical stability

NTK offers various types of ceramic tool material (silicon-nitride-base, alumina-base and whisker-base) in many different shapes to meet the respective requirements of applications for higher efficiency and at higher cutting speed.



● Alumina-based Ceramics (White ceramics)

Can be used for high-speed finishing of normal cast iron thanks to its excellent wear resistance



● Silicon nitride-based ceramics

Best for high-speed roughing of normal cast iron
Machining up to $v_c = 1,000\text{m/min}$ is possible



● Alumina TiC-based ceramics (Black ceramics)

The toughness of this type is improved by adding TiC
Can be used for semi-finishing to finishing for normal cast iron

■ Advantages of ceramic cutting tools①

The material retains high hardness even at elevated temperatures !!

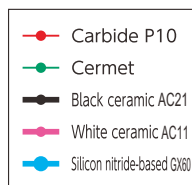

Excellent wear resistance at high cutting speed !

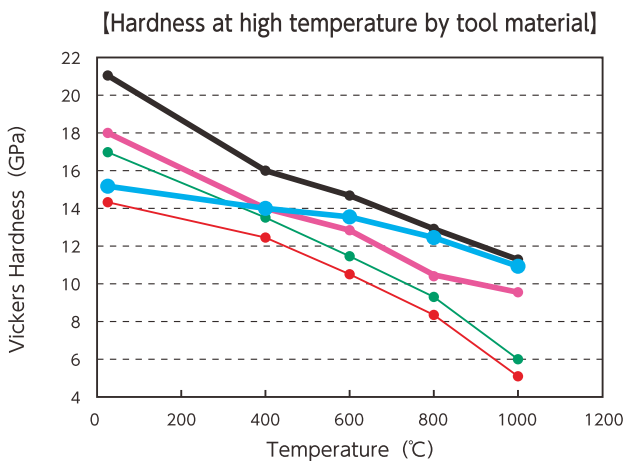

■ Advantages of ceramic cutting tools②

Material breaking strength is not greatly affected by high temperature conditions !!

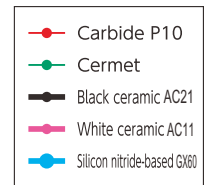

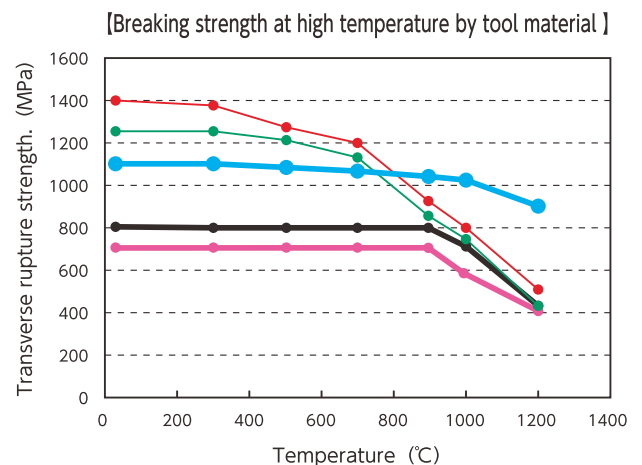

Stable machining is possible in the high speed range



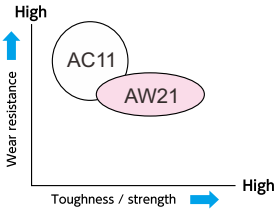

Ceramics

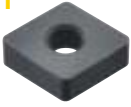
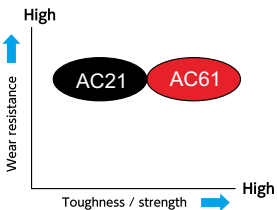
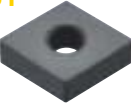
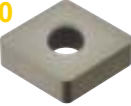
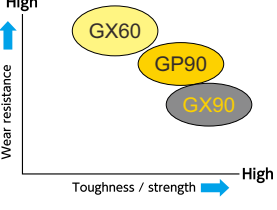
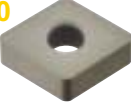
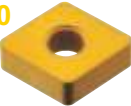
	Material code name / Coating	Applications / Features	Physical properties**					Applications and ceramic property map	
			Density g/cm ³	Hardness HRA	Transverse intensity MPa	Young modulus GPa	Thermal expansion coefficient X10 ⁻⁶ /K		Thermal conductivity W/m·K
White ceramics Alumina - based ceramics	AC11  Al ₂ O ₃	<ul style="list-style-type: none"> Semi-finishing to finishing and grooving of cast iron Tube Scarfing 	4.0	94.0	700	400	7.8	17	[Normal cast iron, Finishing, DRY, White ceramics] 
	AW21  Al ₂ O ₃	<ul style="list-style-type: none"> Semi-finishing to finishing of cast iron Cylinder Liner machining Excellent fracture resistance 	4.1	94.0	750	390	7.8	19	
Black ceramics Alumina + TiC-based ceramics	AC21  Al ₂ O ₃ +TiC	<ul style="list-style-type: none"> Semi-finishing to finishing of cast iron 	4.3	94.5	800	420	7.9	21	[Normal cast iron, Finishing, WET, Black ceramics] 
	AC61  TiC+Al ₂ O ₃	<ul style="list-style-type: none"> Semi-finishing to finishing of ductile cast iron Semi-finishing to finishing of cast iron with coolant 	4.7	94.0	800	450	7.6	29	
Silicon nitride - based ceramics	GX60  Si ₃ N ₄	<ul style="list-style-type: none"> Normal cast iron turning Normal cast iron milling Resistance to insert flank wear 	3.2	93.5	1,200	320	3.0	50	[Cutting of normal cast iron / Roughing] 
	GX90  SiAlON	<ul style="list-style-type: none"> Heat resistant alloy turning Rough turning of normal cast iron High fracture resistance 	3.3	93.5	1,200	330	3.0	15	
	GP90  SiAlON	<ul style="list-style-type: none"> Heat resistant alloy turning Rough turning of normal cast iron Special edge treatment for lower cutting forces + high precision cutting with coated inserts 	3.3	93.5	1,200	330	3.0	15	

Alumina-based ceramics (White ceramics)



- Characterized by high oxidation resistance as well as deposition resistance, these ceramics utilise alumina that is thermally and chemically stable. They are best suited for high-speed cutting applications where the temperature at the edges may become high.

[Normal cast iron, Finishing, Dry cutting, White ceramic]

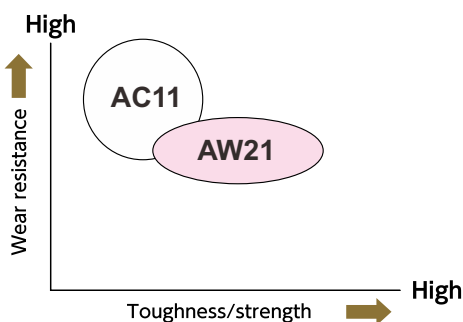

AW21

Highly tough alumina-based ceramic tool !



Features

- Exhibits high strength and high toughness through the addition of zirconium to high purity alumina
- Suitable for semi-interrupted finishing applications for normal cast iron and roughing and finishing of special cast iron (such as lining materials)

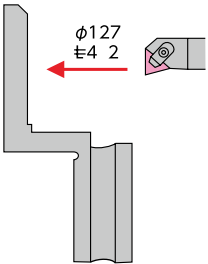
Brake Disc machining	
Work material : FC250	AW21
Cutting speed (m/min) = 359	
Feed rate (mm/rev) = 0.3	
Depth of cut (mm) = 0.5	
Cutting oil : DRY	
FK: AW21	
Competitor's black ceramic	65 pcs./corner
AW21 achieved twice the tool life of the competitor's product, due to its superior strength.	

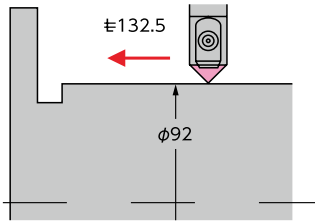
Cylinder liner machining	
Work material : special cast iron	AW21
Cutting speed (m/min) = 600	
Feed rate (mm/rev) = 0.32	
Depth of cut (mm) = 3.0	
Cutting oil : DRY	
FK: AW21	
Competitor's black ceramic	30 pcs./corner
AW21 produced finished surfaces of excellent quality in addition to the life being double that of the competitor's product.	

AC11

Ideal material for high-speed finishing of cast iron !



Features

- Outstanding wear resistance for high-speed cutting of cast iron, especially semi-finishing or finishing without coolant
- Most suitable for high-speed and high-temperature cutting thanks to the high heat resistance, using high-purity alumina as the main component
- Usable even for finishing of special cast iron and for tube scarfing

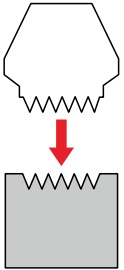
Pulley machining		
Work material : FC250	AC11	
Cutting speed (m/min) = 500		
Feed rate (mm / rev) = 0.15 → 0.10 → 0.05		
Cutting oil : DRY		
FK: AC11		600 pcs./corner
Competitor's black ceramic		300 pcs./corner
AC11 achieved double the tool life of the competitor product.		

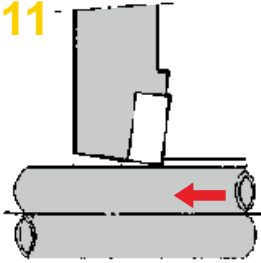
Tube Scarfing	
Work material : SPHT4	AC11
Cutting speed (m/min) = 70	
Depth of cut (mm) = 3.0	
Cutting width (mm) = 5.0	
Cutting oil : DRY	
FK: AC11	
Competitor's black ceramic	30 min./corner
With its outstanding wear resistance characteristic, AC11 produced double the competitors tool life.	



Ceramics

Alumina TiC-based ceramics (Black ceramics)

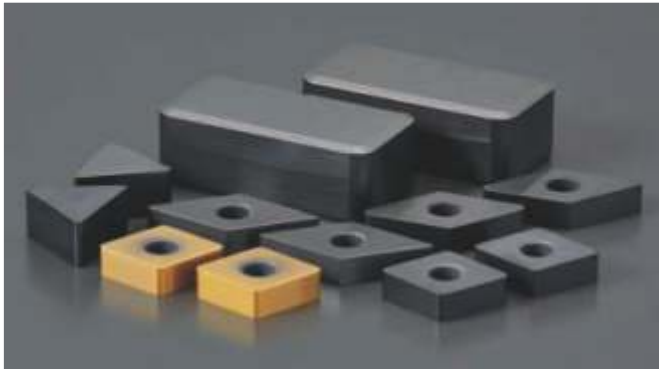

This material group are alumina TiC-based ceramics strengthened by adding hard carbide to high-purity alumina. These tool materials exhibit excellent performance in high-speed finishing of cast iron, applications under either WET or DRY cutting, or even in partially interrupted machining, having improved hardness and strength.

- High hardness and low plasticity in high temperature ranges.

[Normal cast iron, Finishing, WET, Black ceramic]

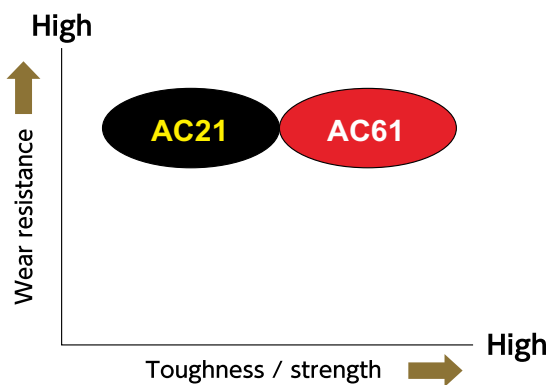

AC21 The standard tool material for machining cast iron and hardened materials !

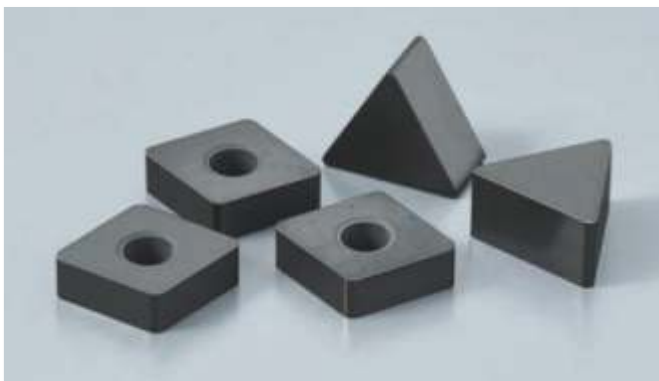

Features

- **Excellent performance in machining of cast iron and hardened materials thanks to its high hardness and low plasticity in high temperature ranges**

Machining of lining material ● Work material : FC material

	Conventional cutting tool Competitor's carbide	FK AC21
Material grade		
Cutting speed (m/min)	400	600
Feed rate (mm /rev)	0.50	←
Depth of cut (mm)	0.70	←
Cutting oil	DRY	←
Life (pcs./corner)	40	110

AC21

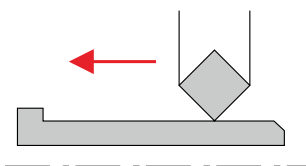

AC21 produced 1.35 times higher machining efficiency and almost 3 times the tool life of the competitor's product.

Machining of roller bearing ● Work material : SNCM (HRC58)

	Conventional cutting tool Competitor's carbide	FK AC21
Material grade		
Cutting speed (m/min)	23	112
Feed rate (mm /rev)	0.06	0.06
Cutting oil	DRY	←
Life (No. of grooves)	4	6

AC21

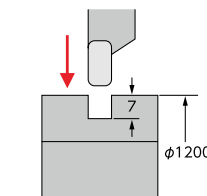

AC21 produced approximately twice the machining efficiency and 1.5 times longer tool life than the competitor's product.

AC61

For machining of ductile cast iron!



Features

- **World's first TiC-based ceramic put into practical use**
- **Ideal for semi-finishing and finishing of ductile cast iron at low to high-speed levels**
- **Also produces excellent dimension stability in machining of cast iron under WET cutting conditions**

Gear cutting ● Work material : Equivalent to FCD450 + copper alloy

	Conventional cutting tool	FK
Material grade	Competitor's cermet	AC61
Cutting speed (m/min)	300	←
Feed rate (mm/rev)	0.05	←
Depth of cut (mm)	0.5	←
Cutting oil	WET	←
Life (pcs/corner)	20	50

AC61

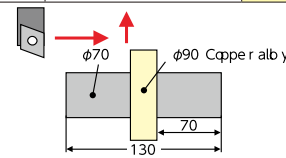

AC61 produced remarkably long life, less dimensional variations and better wear resistance compared with the competitor's product.

■ Cutting performance : V-T curve

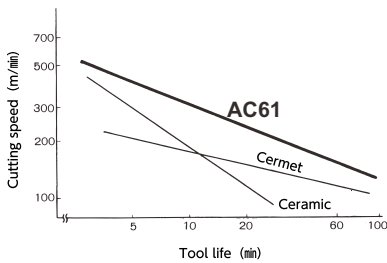

Cutting conditions
 Work material : FCD550(HB240 ~ 260)
 Insert : SNGN120408
 Depth of cut : 0.5mm
 Feed rate : 0.2mm /rev
 Reference life : Amount of VB wear=0.4mm



Ceramics

Silicon nitride-based ceramics



The silicon nitride-based ceramics have approximately twice the fracture toughness of alumina-based, having high fracture resistance equal to some carbide tools. These grades allow efficient machining in high speed ranges where traditional ceramic tools were not able to perform well, including milling of cast iron and interrupted cutting in poor surface conditions.

[Normal cast iron, Roughing]

GX90 Best grade for roughing ductile cast iron



Features

- Excellent notch wear resistance
- Better flank wear resistance compared to competitor's silicon nitride ceramics
- Superior toughness compared to Whisker-reinforced ceramics
- Best thermal shock resistance
- Best grade for roughing Inco 718 with scale

Housing (Ductile Cast Iron)		
Comp. Whisker	GX90	
Shape	CNGN120408	←
Cutting speed (m/min)	180	←
Feed (mm/rev)	0.13	0.2
Depth of cut (mm)	2.5	←
	WET	←
FK: GX90	* High productivity	
Competitor's Whisker ceramic		

GX60 Premium Silicon Nitride



Features

- Excellent wear resistance in applications where notch wear appears
- Stable tool life in the applications where thermal shock resistance is required : such as WET machining or milling
- Long tool life and high productivity at high cutting speed

Brake rotor	
Gray cast iron	
Cutting speed(m/min):1,100	
Feed(mm/rev) : 0.5	
Depth of cut (mm):2.0 ~ 3.0	
WET	
FK: GX60	75 pcs
Competitor's silicon nitride ceramic	50 pcs

GP90 High Speed machining with low cutting forces



Features

- Excellent wear-resistance and chipping resistance with CVD coated high-strength silicon nitride-based ceramic
- Achieves lower tool pressure with minimal edge preparation
- Also usable for finishing

Brake disc	
SG Iron	
Cutting speed (m/min) : 550	
Feed (mm/rev) : 0.4	
DRY	
FK: GP90	120 pcs
Competitor's silicon nitride	80 pcs

High-pressure sintered compact

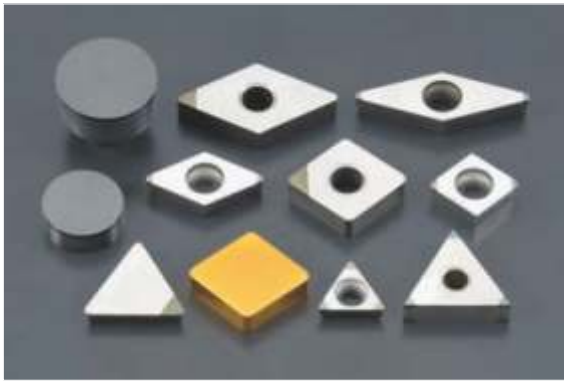

CBN grade inserts are composed mainly of CBN (Cubic Boron Nitride) particles with a special ceramic binder. The material has excellent cutting material properties including high hardness at normal and highly elevated temperatures, little chemical reactions with work materials, making it a material suitable for cutting tools

CBN inserts can be used for machining of cemented materials and high speed machining of cast iron

E16

Best for high efficiency machining of cast iron !



【Actual machining examples】

Rough cutting of disc brake

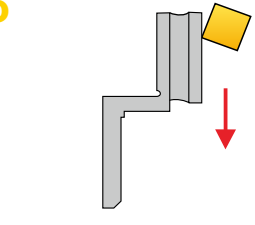
Work material : FC250	
Cutting speed (m/min) = 1,000	
Feed rate (mm/rev) = 0.7	
Depth of cut (mm) = 1.0	
Cutting oil : WET	

FK: E16

800 pcs./corner

Competitor's CBN product

650 pcs./corner

E16 produced tool life of 1.2 times the competitor's product.

Features

- Solid CBN with multiple corners available
- The coating allows easy checking of used cutting edges

Material grade	Main binder	CBN content	Major application
E16	TiN coating + special ceramic	82%	Roughing and finishing of normal cast iron at high speed/rolling rolls

E22

Best for machining of rolls of high hardness !



Features

- Top layer of CBN with a carbide base offering multiple cutting edges
- High hardness due to the use of the special binder

Material grade	Main binder	CBN content	Major application
E22	TiN-base	80%	Turning of very hard rolls

Machining of roll

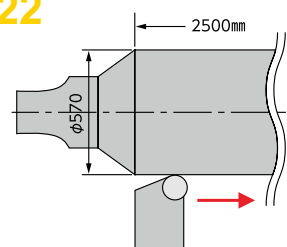
Work material : High chrome cast iron	
Cutting speed (m/min) = 60	
Feed rate (mm/rev) = 0.2	
Depth of cut (mm) = 2.0	
Cutting oil : WET	

FK: E22

2 passes

Competitor's CBN product

1 pass

E22 produces twice the life of the competitor product.

CB³

Brazed CBN inserts offer high performance, low price and versatility !



Features

- Four grades available for different component materials
- Large range for various applications
- Multiple corners on both insert sides contributes to cost reduction

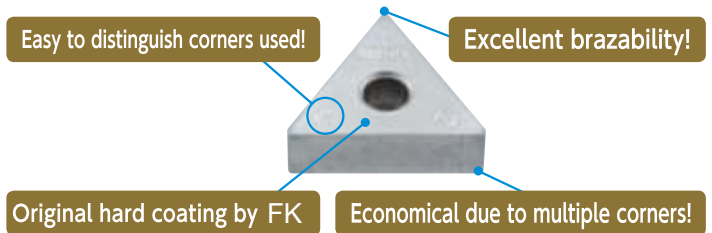

NEW CBN (Cubic Boron Nitride)

• FLITZEN CB³

Material grade	Main binder	CBN content	Major application
E5K *	TiC-base	50%	Continuous to semi-interrupted machining of hardened steels Finishing of ductile cast iron
E52	TiC-base	50%	Finishing of ductile cast iron and continuous machining of highly hardened materials
E23	Ti-base	90%	High-speed semi roughing of cast iron/sintered alloys
E30	Ti-base	95%	High-speed finishing of cast iron

*PVD coating CBN

[Actual machining examples]

Continuous boring on cylinder block

Work material : FC material **E30**

Cutting speed (m/min) = 800

Feed rate (mm / rev) = 0.3

Depth of cut (mm) = 0.1

Cutting oil : WET

FK: E30	800 pcs./corner
Competitor's CBN product	500 pcs./corner

The life of E30 grade inserts was 1.6 times as long as the competitor's product.

Arial Narrow Bolg

Work material : FCD600 **E52**

Cutting speed (m/min) = 350~400

Feed rate (mm / rev) = 0.08

Depth of cut (mm) = 0.2

Cutting oil : WET

FK: E52	60 pcs./corner
Competitor's CBN product	30 pcs./corner

The life of E52 grade inserts was twice that of the competitor product.

Cutting of outer side of oil pump housing

Work material : FC250 **E23**

Cutting speed (m/min) = 250

Feed rate (mm / rev) = 0.2

Depth of cut (mm) = 2.0

Cutting oil : WET

FK: E23	210 pcs./corner
Competitor's CBN product	70 pcs./corner

The life of E23 grade inserts was 3 times as long as the competitor's product.

JCWM

Stable gray cast iron milling with lower cutting force

- Maximizes ceramic insert potential and can mill faster than 1,000m/min



→ 11

JCFM

- Extremely economical as SNGN1204 style inserts with 8 cutting edges can be used
- Capable of producing excellent surface finish, by utilising inserts with chipbreakers and wiper facets

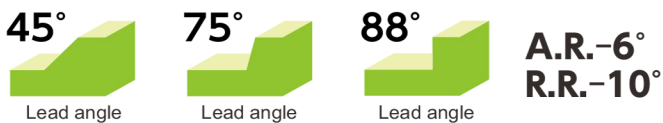

→ 13

NEW

JCTM

- Economical & Multi-Functional
- TNGN 1604 style inserts with 6 cutting edges
- Low Cutting Force

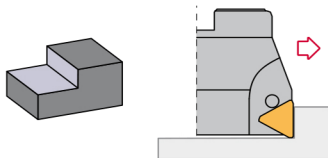

NEW



→ 14

FCI

- Hybrid Milling Cutter with adjustable inserts
- Finishing Cast Iron by using GX60 & E30



NEW



→ 15



OVERVIEW

LNFM

- Offers high efficiency machining due to the multi-blade design and possibility for greater depth of cut
- Offers a reduction in cutting force via our special chipbreaker design

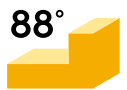

Lead angle

A.R.-4°
R.R.0°



→ 16

APCE / APCS

- Ceramic milling cutter capable of shoulder milling now released
- Accommodates from $\varnothing 20$ up to $\varnothing 250$ cutters

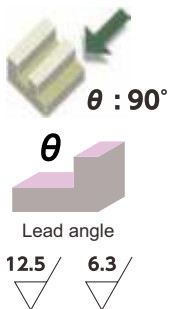

→ 17



→ 17



Milling Cutters

JCWM

- Stable gray cast iron milling with lower cutting force

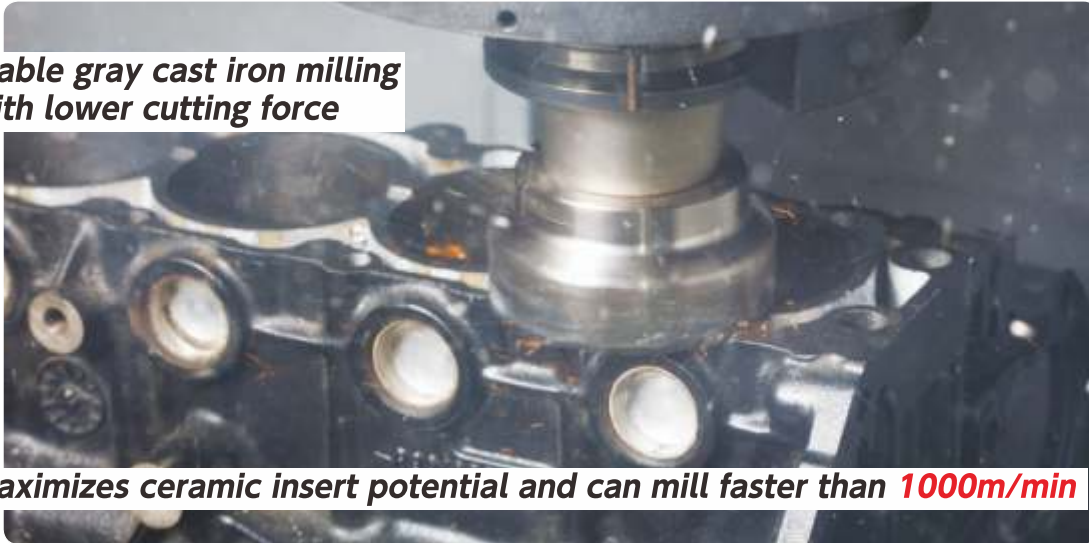

- Maximizes ceramic insert potential and can mill faster than **1000m/min**

Thanks to lower cutting forces, work piece chipping is reduced
Apply depth of cut up to A_p 6mm

Ceramic with Si_3N_4 is the best choice for roughing cast iron with scale. Tool pressure is reduced because of the sharper cutting edge and the ground-in chipbreaker



Available cutter dia. $\phi 63$ - $\phi 160$

Very cost efficient with a unique 6 cutting edge design

Thanks to low-cutting resistance, machine over load is avoided

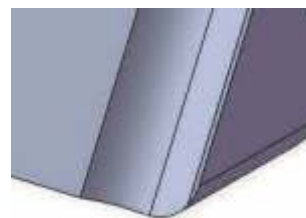
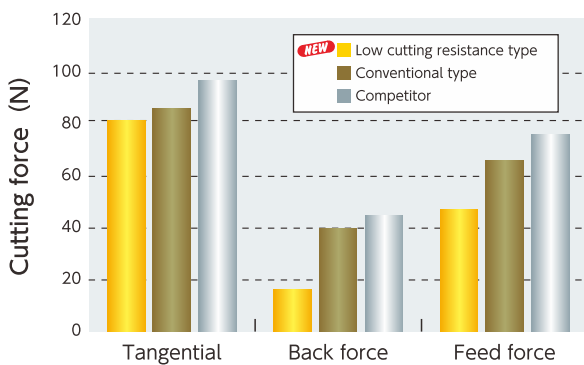

【Radius type】

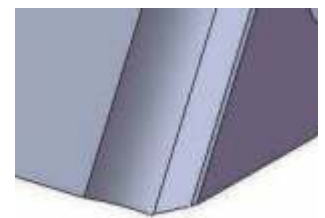

【Chamfered type】

Two edge preparation are available.
Radius type good for high feed milling.
Chamfered type with excellent edge sharpness.

Cutting condition

$V_c=800m/min$ $f_z=0.10mm/t$ $a_p=3.0mm$ $a_e=80.0mm$

Cycle time reduction with single pass and achieve longer tool life.
Lesser machine horsepower required.



Milling Cutters



A. R. +5°
R. R. +4°, +7°, +10°

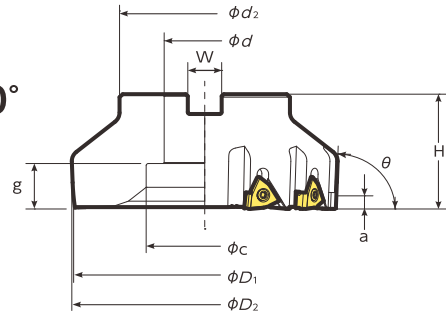
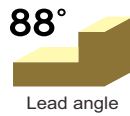

JCWM type milling body

θ	Part number	Stock	No of inserts	Dimensions (mm)										Weight (kg)	Rake angle (°)		Centering location type
				ϕD ₁	ϕD ₂	H	a※1	a※2	ϕd ₁	W	ϕd ₂	ϕc	g		A.R.	R.R.	
88°	JCWM063-88-06R-S	●	6	63	63	50	5.5	4.5	22	10.4	60	18	15.5	0.9	+5	+4	FMC
	JCWM080-88-08R-S	●	8	80	80				25.4	9.5		36	15			1.1	
	JCWM100-88-10R-S	●	10	100	100				31.75	12.7	80	50	18	1.8		+10	FMA
	JCWM125-88-12R-S	●	12	125	125				38.1	15.9		55	23	3			
	JCWM160-88-16R-S	●	16	160	160				60	50.8	19.0	100	72	22			

※1 Dimension when set the insert WNX1204-C10T01020
※2 Dimension when set the insert WNX1204-R12T01020

Parts	
Clamping Screw FSI 26-4.0×12-LH 5861935 Sales quantity 10pcs/case	Wrench LLR-T15 5701909 Sales quantity 5pcs/case

Insert

Shape	Dimensions (mm)	Part number	C or r _ε	Grade	
		WNX1204-C10T01020	C1.0	GX60	●
				GP90	●
		WNX1204-R12T01020	R1.2	GX60	●
				GP90	●

Recommended cutting conditions

Grade	Work material	Cutting speed (m/min)												Feed (mm/t)					Depth of cut (mm)
		400	500	600	700	800	900	1000	1100	1200	1300	1400	0.05	0.1	0.15	0.2	0.25	0.3	
GX60	Gray cast iron	[Red bar with vertical lines]												[Red bar with vertical lines]					~6 (mm)
		[Yellow bar with faucet icon]												[Yellow bar with faucet icon]					
GP90	Ductile cast iron	[Red bar with vertical lines]												[Red bar with vertical lines]					

Case study

Transmission case			● Work material : FC23
	current tool	FK	
Holder	Competitor	JCWM125A3810R12	
Insert	Ceramic insert	GX60 WNX1204-R12T01020	
Cutting speed (m/min)	500	←	
Feed per tooth (mm/t)	0.13	←	
Depth of cut (mm)	1	←	
Coolant	DRY	←	
Tool life (pcs/coner)	60	120	

As for competitor's milling cutter, we needed to change inserts to new ones due to the wearprogress and lower clamping force of work material after machining 60 pcs. This was caused by increasing Cutting force. Flitzen Keramik New JCWM Cutters achieved 2 times longer competitor's. Low cutting force avoided the problem occurred by competitor's milling cutter.



Milling Cutters

JCFM Cutter

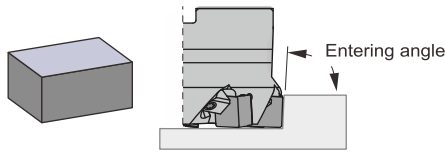

45°, 75°, 88°, 90°
Adjustable Cutter available!

Characteristics:
Negative milling cutter with 45°, 75°, 88°, 90° entering angle. Its strong inserts accept high cutting depths and high feed per teeth. First option for cast iron milling.

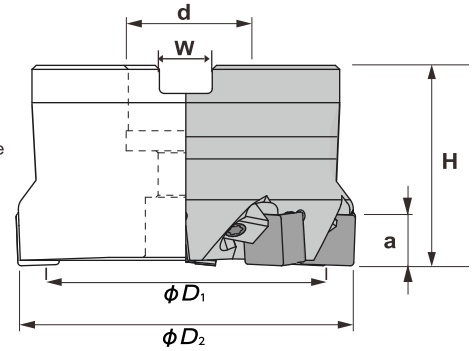

Spare parts

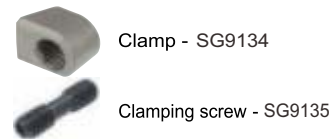

θ	Reference	Standard	φ	Dimensions (mm)							Weight (kg)
				φD ₁	φD ₂	H	a	φd	W	φd ₂	
45°	JCFM 050-45-05R-GM	●	5	50	58	50	8	22	10,4	45	0.78
	JCFM 063-45-06R-GM	●	6	63	72	50	8	22	10,4	58	0.93
	JCFM 080-45-08R-GM	●	8	80	95	50	8	27	12,4	62	1.21
	JCFM 100-45-10R-GM	●	10	100	120	50	8	32	14,7	62	1.66
	JCFM 125-45-13R-GM	●	13	125	146	58	8	40	16,4	83	2.80
75°	JCFM 050-75-05R-GM	●	5	50	57	50	12	22	10,4	45	0.65
	JCFM 063-75-06R-GM	●	6	63	70	50	12	22	10,4	58	0.79
	JCFM 080-75-08R-GM	●	8	80	87	50	12	27	12,4	62	1.06
	JCFM 100-75-10R-GM	●	10	100	107	50	12	32	14,7	62	1.39
	JCFM 125-75-13R-GM	●	13	125	132	58	12	40	16,4	83	2.56
	JCFM 160-75-16R-GM	●	16	160	166	60	12	40	16,4	100	4.1
88°	JCFM 050-88-05R-GM	●	5	50	51	50	12	22	10,4	45	0.65
	JCFM 063-88-06R-GM	●	6	63	64	50	12	22	10,4	58	0.79
	JCFM 080-88-08R-GM	●	8	80	81	50	12	27	12,4	62	1.06
	JCFM 100-88-10R-GM	●	10	100	101	50	12	32	14,7	62	1.39
	JCFM 125-88-13R-GM	●	13	125	126	58	12	40	16,4	83	2.56
	JCFM 160-88-16R-GM	●	16	160	156	60	12	40	16,4	100	4.1
90°	JCFM 050-90-05R-GM	●	5	50	50	50	12,7	22	10,4	45	0.65
	JCFM 063-90-06R-GM	●	6	63	63	50	12,7	22	10,4	58	0.79

Applicable inserts

Shape	Dimensions (mm)	Reference	R	Silicon Nitride	
				GX60	GP90
 12.5		SNGN 120408 T02020	0.8	●	●
		SNGN 120412 T02020	1.2	●	●
		SNGN 120416 T02020	1.6	●	●
 with chipbreaker		SNGC 120412 FM-C	1.2	●	●
 with wiper		SNGN 1204AN W	—	●	●
Dimensions (mm)		Reference	R	CBN	
				E30	E52
 θ=45°		FDX 1204-45-50R	—	●	●

Milling Cutters

NEW

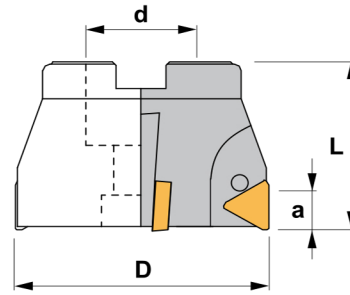
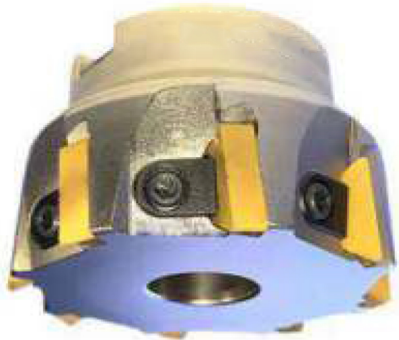

JCTM Cutter

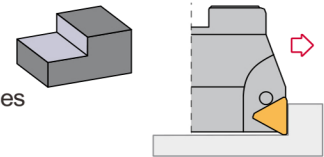

Characteristics:

Economical & Multi-Functional
TNGN 1604 style inserts with 6 cutting edges



Reference		D	L	a	d	Insert	
JCTM050-90-06-GM	06	50	50	16	22	TNGN 1604..	0,78
JCTM063-90-08-GM	08	63	50	16	27	TNGN 1604..	0,93
JCTM080-90-10-GM	10	80	50	16	27	TNGN 1604..	1,21
JCTM100-90-14-GM	14	100	50	16	32	TNGN 1604..	1,66
JCTM125-90-16-GM	16	125	63	16	40	TNGN 1604..	2,80

Spare parts



Clamp - SG9134



Clamping screw- SG9135



Applicable insert

TNGN Triangular negative insert.

Reference	l	s	d
TNGN 1604..	16,50	4,76	9,52

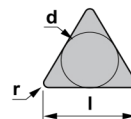

TNGN





Milling Cutters

NEW

FCI Cutter

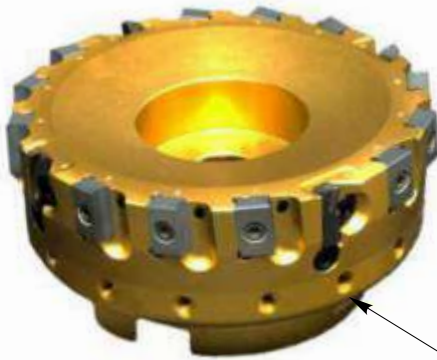

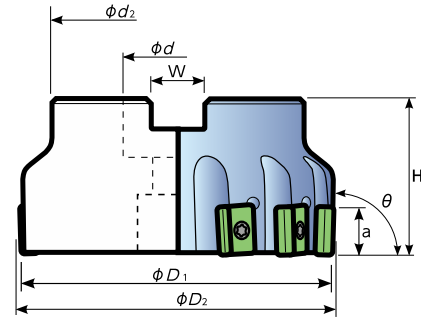

A.R.-4°
R.R.0°





Adjustable HTX-Insert

θ	Reference	Standard	Standard	Dimensions(mm)									Weight (kg)
				φD ₁	φD ₂	H	a	φd	W	φd ₂	φc	g	
88°	FCI063-88-06/2-SA	●	6/2	63	66	50	14	22	10,4	58			0,76
	FCI080-88-08/2-SA	●	8/2	80	83	50	14	27	12,4	58			0,96
	FCI100-88-10/3-SA	●	10/3	100	103	50	14	32	14,7	77			1,47
	FCI125-88-12/4-SA	●	12/4	125	128	58	14	40	16,4	77			1,92

Spare parts

Parts LNX-Inserts	
Clamping screw 	Wrench 
FCI-CS-01 10pcs/case	FCI-WR-02 1pcs/case

Parts HFT-Inserts				
Wedge	Axial set screw		Wedge set screw	
	Screw	Screwdriver	Screw	Screwdriver
				
FCI-CW-03	FCI-CS-04	FCI-SD-05	FCI-CS-06	FCIW-2.5

Applicable inserts

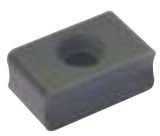
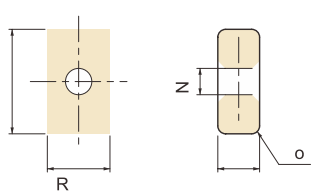
Shape	Dimensions	Part No.	R	Grade
		LNHX 324-08 T00520	0.8	GX60 ●

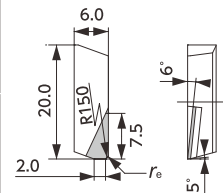
Wiper	Shape	Item Number	Corner angle	Max DOC (mm)		A.R.	r _ε (mm)	CBN
				AL	GG			E30
Yes (Rounded)	 <p>For Standard use</p>	HTX 802006 C05	90°	7.5	0.5	6°	C0.5	●
Yes (Rounded)		HTX 802006 R04	90°	7.5	0.5	6°	R0.4	●



Milling Cutters

LNFM Cutter



A.R.-4°
R.R.0°



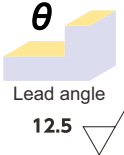

$\theta : 88^\circ$

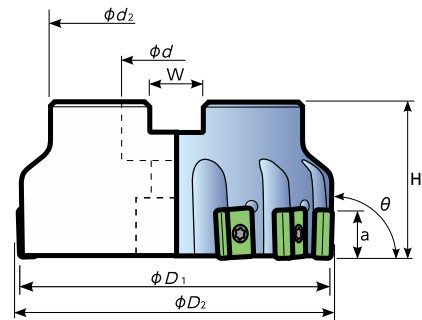

Lead angle
12.5







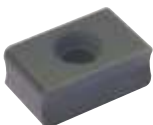
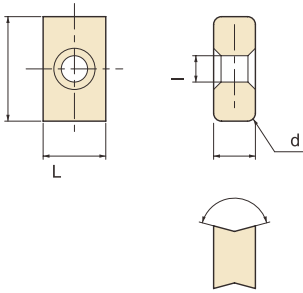

θ	Reference	Standard	Standard	Dimensions(mm)									Weight (kg)
				ϕD_1	ϕD_2	H	a	ϕd	W	ϕd_2	ϕc	g	
88°	LNFM080-88-10R-GM	●	10	80	83	50	14	27	12,4	58			1.1
	LNFM100-88-13R-GM	●	13	100	103	50	14	32	14,7	77			1.8
	LNFM125-88-16R-GM	●	16	125	128	58	14	40	16,4	77			3.1

Parts	
Clamping screw 	Wrench 
LNS-4*2 10pcs/case	LNW-25S 1pcs/case

Applicable inserts

Shape	Dimensions	Part No.	R	Grade
		LNCT 324-08T01020	0.8	GX60 ●
				GX90 ●
		LNCT 324-12T01020	1.2	GX60 ●
				GX90 ●
		LNCT 324-16T01020	1.6	GX60 ●
				GX90 ●

● : Standard

Recommended cutting conditions														
Grade	Work material	Cutting speed (m/min)								Feed rate (mm/tooth)				Depth of cut (mm)
		400	500	600	700	800	900	1000	1100	0.05	0.1	0.15	0.2	
GX60	Normal cast iron													~ 8 (mm)
														
GX90	Ductile cast iron													



Milling Cutters

APCS Cutter

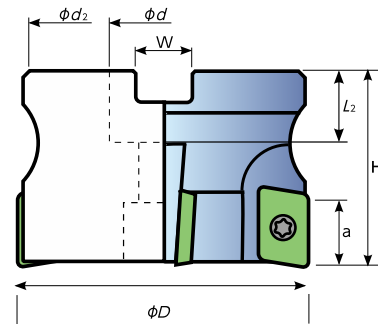

Reference	Standard	Flutes	Dimensions (mm)							Weight (kg)	A.R.	R.R.	Insert Screw	Wrench	Insert
			ϕD	H	L_2	a	ϕd	W	ϕd_2						
APCS040-90-4R-GM	●	4	40	40	18	14	16	8.4	35	0.2	+6°	-13°	APS - 4*11	T-15A	APCK 1604
APCS050-90-5R-GM	●	5	50	40	22	14	22	10.4	45	0.3	+6°	-10°			
APCS063-90-6R-GM	●	6	63	50	22	14	22	10.4	58	1.4	+6°	-12°			
APCS080-90-8R-GM	●	8	80	50	25	14	27	12.4	58	1.9	+6°	-12°			

APCE Cutter

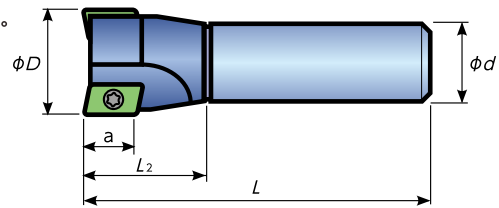
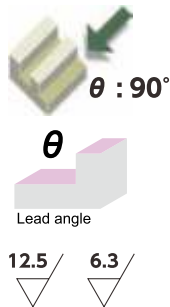

Reference	Standard	Flutes	Dimensions (mm)					Weight (kg)	A.R.	R.R.	Insert Screw	Wrench	Insert
			ϕD	L	L_2	a	ϕd						
APCE020-90-1R-GM	●	1	20	100	30	14	20	0.2	+6°	-13°	APS - 4.0 * 7	T-15A	APCK 1604
APCE025-90-2R-GM	●	2	25	100	30	14	25	0.3	+6°	-13°			
APCE032-90-3R-GM	●	3	32	110	35	14	32	0.5	+6°	-13°			
APCE040-90-4R-GM	●	4	40	110	37	14	32	0.6	+6°	-13°			

Inserts

Shape	Reference	R	m	Silicon Nitride	
				GX60	GP90
	APCK 160408 T01020	0.8	7.314	●	●
	APCK 160412 T01020	1.2	7.278	●	●
	APCK 160420 T01020	2.0	7.205	●	●
 With Wiper	APCK 1604 TW	—	7.163	●	●

Recommended Cutting Conditions





Work Material	Grade	Dry	Wet	Cutting Speed (m/min)								Feed (mm/t)						Depth of Cut (mm)	
				200	350	500	650	800	950	1100	1250	0.05	0.1	0.15	0.2	0.25	0.3		
Gray Cast Iron	GX60	●	○																~ 8.0
	GP90	●	●																~ 8.0
Ductile Iron	GP90	●	○																~ 8.0

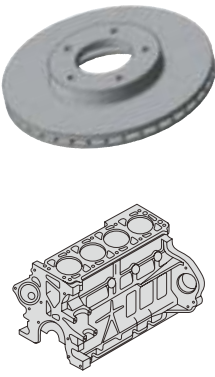

Tool Materials / Selection Guide

Recommended Types of Materials and Applications : Ceramic and CBN

● First Choice ○ Second Choice

Work material	Tool material	Process			Cutting oil					
		Rough-ing	Semi-finishing	Finishing	Continuous	Light interruption	Interruption	Dry	Wet	
Normal cast iron 	Ceramic	GX60	●	○		●	○	●	●	
		GX90	●	○		●	○	●	●	
		GP90		○		●	○		●	○
		AC11/AW21			○	○			●	
		AC21/AC61			○	○			●	●
	C BN	E23	●	○		●	○		○	●
		E30		○		●	○		○	●
E16		○					○	○	●	
Special cast iron 	Ceramic	AW21	●	○		○		●		
		AC21		○		○		●	○	
Ductile cast iron 	Ceramic	GX90	●	○		●	○	●	○	
		GP90	●	○		●	○	●	○	
		AC61			○	○		○	●	
	C BN	E52			○	○		○	●	
Rolls 	Ceramic	AC21	●	○		○		●	○	
		C BN	E22/E30		○		○		●	○
	Ceramic	GX90	●	○		○		●	○	
		C BN	E22/E52		○		○		●	○



Tool Materials / Selection Guide

Cutting speed(m/min) 50 100 200 300 400 500 600 700 800 900 1000 1200											Feed rate(mm/rev) 0.1 0.2 0.3 0.4 0.5 0.6					Depth of cut(mm) 0.5 1.0 2.0 3.0 4.0 5.0 6.0																		



FLITZEN KERAMIK

E-mail: sales@flitzenkeramik.com
Web: <https://www.flitzenkeramik.com>